

# ***Ampeg***

**BA-108, BA-110, BA-112, BA-115 and BA-210**

**Bass Guitar Combo Amplifiers**

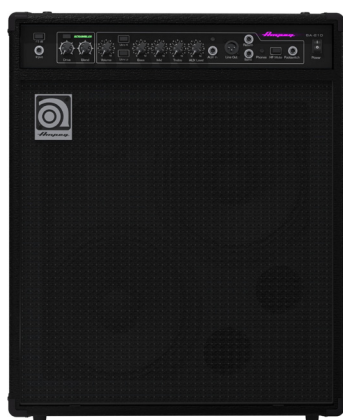

**Owner's Manual**



### IMPORTANT SAFETY INSTRUCTIONS

1. Read these instructions.
2. Keep these instructions.
3. Heed all warnings.
4. Follow all instructions.
5. Do not use this apparatus near water.
6. Clean only with a dry cloth.
7. Do not block any ventilation openings. Install in accordance with the manufacturer's instructions.
8. Do not install near any heat sources such as radiators, heat registers, stoves, or other apparatus (including amplifiers) that produce heat.
9. Do not defeat the safety purpose of the polarized or grounding-type plug. A polarized plug has two blades with one wider than the other. A grounding-type plug has two blades and a third grounding prong. The wide blade or the third prong are provided for your safety. If the provided plug does not fit into your outlet, consult an electrician for replacement of the obsolete outlet.
10. Protect the power cord from being walked on or pinched particularly at plugs, convenience receptacles, and the point where they exit from the apparatus.
11. Only use attachments/accessories specified by the manufacturer.
12. Use only with a cart, stand, tripod, bracket, or table specified by the manufacturer, or sold with the apparatus. When a cart is used, use caution when moving the cart/apparatus combination to avoid injury from tip-over.



**WARNING** — To reduce the risk of fire or electric shock, do not expose this apparatus to rain or moisture.

**CAUTION** — To prevent electric shock hazard, do not connect to mains power supply while grille is removed.

Laitte on liitettävä suojakoskettimilla varustettuun pistorasiaan.

Apparatet må tilkoples jordet stikkontakt.

Apparaten skall anslutas till jordat uttag.

13. Unplug this apparatus during lightning storms or when unused for long periods of time.
14. Refer all servicing to qualified service personnel. Servicing is required when the apparatus has been damaged in any way, such as power-supply cord or plug is damaged, liquid has been spilled or objects have fallen into the apparatus, the apparatus has been exposed to rain or moisture, does not operate normally, or has been dropped.
15. This apparatus shall not be exposed to dripping or splashing, and no object filled with liquids, such as vases or beer glasses, shall be placed on the apparatus.
16. Do not overload wall outlets and extension cords as this can result in a risk of fire or electric shock.
17. This apparatus has been designed with Class-I construction and must be connected to a mains socket outlet with a protective earthing connection (the third grounding prong).
18. The MAINS plug or an appliance coupler is used as the disconnect device, so the disconnect device shall remain readily operable.
19. For the terminals marked with symbol of “⚡” may be of sufficient magnitude to constitute a risk of electric shock. The external wiring connected to the terminals requires installation by an instructed person or the used of ready-made leads or cords.

	Disconnect power before fuse replacement.
	Replace only with certified/approved fuse of same type, size and ratings as marked on product.

	<b>CAUTION</b>	
<b>RISK OF ELECTRIC SHOCK! DO NOT OPEN!</b>		
CAUTION: TO REDUCE THE RISK OF ELECTRIC SHOCK DO NOT REMOVE COVER (OR BACK). NO USER-SERVICEABLE PARTS INSIDE. REFER SERVICING TO QUALIFIED PERSONNEL.		

The lightning flash with arrowhead symbol within an equilateral triangle means “electric shock hazard”. It is intended to alert the user to the presence of uninsulated “dangerous” voltage within the product enclosure, that may be of significant magnitude to constitute a risk of electric shock to persons.

The exclamation point within an equilateral triangle means “Warning/Caution!”. It is intended to alert the user of the presence of important operating and maintaining (servicing) instructions in the literature accompanying the appliance.



**NOTE:** This equipment has been tested and found to comply with the limits for a Class B digital device, pursuant to part 15 of the FCC Rules. These limits are designed to provide reasonable protection against harmful interference in a residential installation. This equipment generates, uses, and can radiate radio frequency energy and, if not installed and used in accordance with the instructions, may cause harmful interference to radio communications. However, there is no guarantee that interference will not occur in a particular installation. If this equipment does cause harmful interference to radio or television reception, which can be determined by turning the equipment off and on, the user is encouraged to try to correct the interference by one or more of the following measures:

- Reorient or relocate the receiving antenna.
- Increase the separation between the equipment and the receiver.
- Connect the equipment into an outlet on a circuit different from that to which the receiver is connected.
- Consult the dealer or an experienced radio/TV technician for help.

**CAUTION:** Changes or modifications to this device not expressly approved by LOUD Technologies Inc. could void the user's authority to operate the equipment under FCC rules.

This apparatus does not exceed the Class A/Class B (whichever is applicable) limits for radio noise emissions from digital apparatus as set out in the radio interference regulations of the Canadian Department of Communications.

Exposure to extremely high noise levels may cause permanent hearing loss. Individuals vary considerably in susceptibility to noise-induced hearing loss, but nearly everyone will lose some hearing if exposed to sufficiently intense noise for a period of time. The U.S. Government's Occupational Safety and Health Administration (OSHA) has specified the permissible noise level exposures shown in the following chart.

According to OSHA, any exposure in excess of these permissible limits could result in some hearing loss. To ensure against potentially dangerous exposure to high sound pressure levels, it is recommended that all persons exposed to equipment capable of producing high sound pressure levels use hearing protectors while the equipment is in operation. Ear plugs or protectors in the ear canals or over the ears must be worn when operating the equipment in order to prevent permanent hearing loss if exposure is in excess of the limits set forth here:

Duration, per day in hours	Sound Level dBA, Slow Response	Typical Example
8	90	Duo in small club
6	92	
4	95	Subway train
3	97	
2	100	Very loud classical music
1.5	102	
1	105	The boss screaming at his minions about manual deadlines
0.5	110	
0.25 or less	115	Loudest parts of a rock concert



**Correct disposal of this product:** This symbol indicates that this product should not be disposed of with your household waste, according to the WEEE directive (2012/19/EU) and your national law. This product should be handed over to an authorized collection site for recycling waste electrical and electronic equipment (EEE). Improper handling of this type of waste could have a possible negative impact on the environment and human health due to potentially hazardous substances that are generally associated with EEE. At the same time, your cooperation in the correct disposal of this product will contribute to the effective usage of natural resources. For more information about where you can drop off your waste equipment for recycling, please contact your local city office, waste authority, or your household waste disposal service.



**TABLE OF CONTENTS**

Important Safety Instructions .....	2-3
Table Of Contents .....	4
Introduction .....	5
BA Series Features .....	5
BA Series Front Panel Features.....	6-7
BA Series Front and Rear Panel Features.....	8
Favorite Settings.....	9
BA-108 Technical Specifications and Block Diagram.....	10
BA-110 Technical Specifications and Block Diagram.....	11
BA-112 Technical Specifications and Block Diagram.....	12
BA-115 Technical Specifications and Block Diagram.....	13
BA-210 Technical Specifications and Block Diagram.....	14
Service Information .....	15



### Introduction

Completely redesigned, Ampeg's all-new BA Series Combos feature legacy Ampeg preamp and tone stack circuits with a wide range of classic Ampeg tones. The modern, flexible designs include a true 60° sound reinforcement monitor angle that directs sound right to your ears, adding clarity and definition in any situation.

Plus, performance-driven features like integrated DIs and effects loops are perfect for serious gigging and rehearsal. Portable by design and built for gigging, a protective all-steel amp chassis, durable double-thick Tolex® and metal corners deliver the durability you need during transport.

Like all Ampeg products, your BA combo is designed by musicians and built using only the best of components. Each combo is tested to confirm that it meets our specifications, and we believe that this combo is the absolute best that it can be.

In order to get the most out of your new combo, please read this manual before you begin playing. Best of luck in all of your musical endeavors!

And **thank you** for choosing Ampeg.

### BA Series Features:

- Classic Tone
  - Legacy Ampeg preamp and tone stack circuits
  - Ampeg Ultra Hi/Lo tone shaping\*
  - Bass Scrambler™ overdrive for SVT grind\*
  - Perfectly-matched Ampeg Custom™ speakers
- Modern Flexibility
  - True 60° sound reinforcement monitor angle
  - Integrated DIs, effects loops, extension speaker outs\*
  - Aux in / headphone outs
- Rugged Portability
  - Protective all-steel amp chassis
  - Impact-resistant metal corners
  - Durable double-thick Ampeg classic black Tolex®
  - Rugged, braced enclosures

\* Some features available on select models only.



### BA Series Front Panel Features

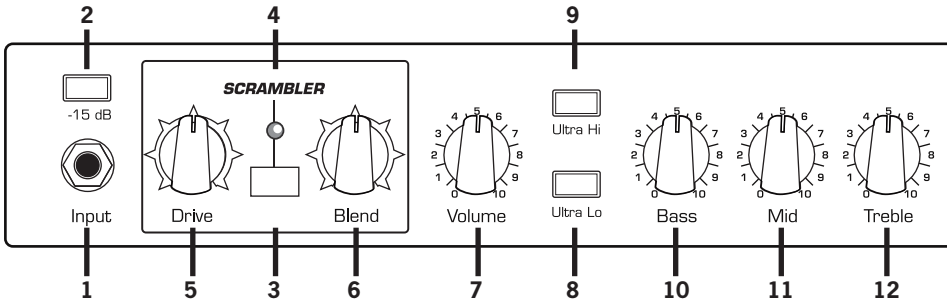

- 1. INPUT:** The signal output from an instrument (active or passive) may be connected to this 1/4" input by means of a shielded instrument cable.
- 2. -15 dB:** Press this switch in to reduce the input signal by 15 dB and compensate for higher output sources. This attenuation is suited for use with basses that have active electronics or high-output pickups.
- 3. SCRAMBLER:** Engage this switch to activate the Bass Scrambler™ overdrive circuit. This allows for varying amounts of tube-like grind and distortion.
- 4. SCRAMBLER LED:** This LED illuminates green when the Bass Scrambler™ overdrive is on.
- 5. DRIVE:** Use this to adjust the amount of Bass Scrambler™ overdrive effect. Rotate the control clockwise for a more overdriven sound, or counter-clockwise for a less overdriven sound.
- 6. BLEND:** Use this to blend the Bass Scrambler™ affected signal with the clean unaffected signal.
- 7. VOLUME:** Use this to control the overall output level. It affects the preamp level to speaker and phone outputs. Use it wisely, and turn it down when making connections, putting on headphones, or trying something new. It does not affect the signal fed to the aux input.
- 8. ULTRA LO:** This switch, when engaged, enhances the amount of low-end output by 1 dB at 40 Hz and -10 dB cut at 500 Hz. [BA-112, BA-115, BA-210]
- 9. ULTRA HI:** This switch, when engaged, enhances the amount of high frequency output by 5 dB at 8 kHz. [BA-112, BA-115, BA-210]
- 10. BASS:** Use this to adjust the low frequency level of the amplifier. The low frequency output is flat at the center position. See pages 10-14 for technical specifications.
- 11. MID:** Use this to adjust the midrange frequency level of the amplifier. The midrange frequency output is flat at the center position. Rotate the control counter clockwise for a "contoured" sound (more distant, less midrange output) or clockwise for a sound which really cuts through. See pages 10-14 for technical specifications.
- 12. TREBLE:** Use this to adjust the high frequency level of the amplifier. The high frequency output is flat at the center position. See pages 10-14 for technical specifications.



### BA Series Front Panel Features

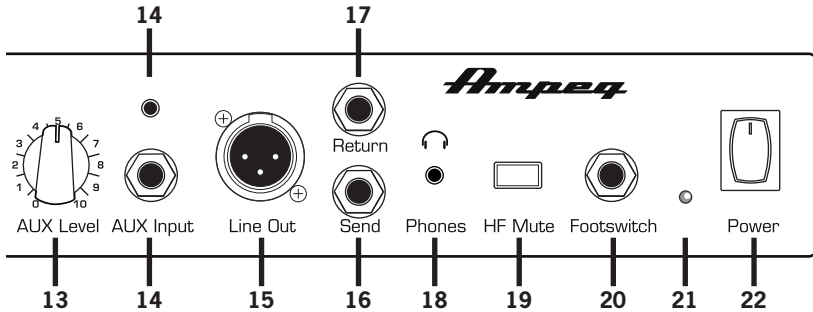

**13. AUX LEVEL:** Use this to control the output level of the signal fed to the aux input. Use it wisely, and turn it down when making connections, putting on headphones, or trying something new.

**14. AUX INPUT:** The audio output from line-level sources, such as an iPod®, MP3, or CD player, can connect to either of these inputs. The incoming audio is mixed with the preamp signals, so you can play along to a practice track, as you listen with headphones.

**15. XLR LINE OUT JACK:** Typically, you would connect this post-EQ, unbalanced output to the unbalanced input of an external mixer, or a recorder. In this way, you do not have to mic the speaker cabinet in order to add it to the main mix, or to record. The level of this signal is affected by the volume control.

This output can connect to external power amplifiers, or powered loudspeakers, as long as they have their own input controls to adjust the volume level.

[BA-115, BA-210]

**16. EFFECTS SEND JACK:** Use this 1/4" TS unbalanced output to send a line-level output to an external effects processor (for example). The output here is affected by all controls except the aux level.

Use the effects return jack to feed the returned processed signals back into the power amplifier.  
[BA-115, BA-210]

**17. EFFECTS RETURN JACK:** Use this 1/4" TS unbalanced input to return the processed line-level output of an external effects processor (for example). The processor could be fed by signals from the effects send.  
[BA-115, BA-210]

**18. PHONES:** Use this 1/8" TRS stereo output to connect your headphones. The output here is a mix of the line-level signals reaching the amplifier, and any incoming audio from the aux input jacks.



Before putting on headphones, make sure the volume and aux controls are turned down, and (if connected) any external audio source has its level turned down. This will reduce the chance of hearing damage due to loud volumes.

**NOTE:** Speakers are muted when headphones are plugged in.



### BA Series Front and Rear Panel Features

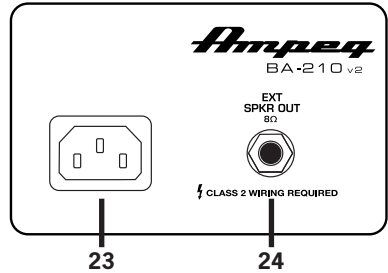
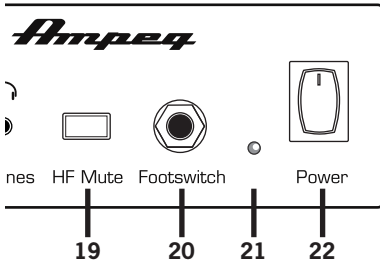

**19. HF MUTE:** Press this switch in to mute the high-frequency output. [BA-115, BA-210]

**20. FOOTSWITCH:** Connect a single or dual footswitch to this jack for Scrambler on/off control. [BA-112, BA-115, BA-210]

**NOTE:** A footswitch may be purchased at your local Ampeg Dealer or ordered directly from LOUD Technologies Inc. Be sure to ask for model #AFP1, #AFP2 or #AFP3.

**21. ON LED:** This LED illuminates red when the power is on.

**22. POWER SWITCH:** Use this switch to turn the overall system power on or off. Press the top of the switch to turn on the power, and press the bottom to turn it off.

**23. POWER CONNECTOR:** This is where you connect the supplied AC power cord.



Before plugging in the power cord, make sure that the voltage selector switch is set to the same voltage as your local AC mains.

**24. EXT SPKR OUT:** Use this 1/4" TS output jack to connect the amplifier to an 8 Ω extension speaker. The internal speaker remains active when an extension speaker is connected.



Use a speaker cable with 1/4" TS ends only to make the connection. Do not use instrument cables as they may overheat.

[BA-210]







## Favorite Settings







-15 dB  
 Input

**SCRAMBLER**  
 Drive:  Blend: 



Ultra Hi  
 Ultra Lo

Volume: 

Bass:  Mid:  Treble:  AUX Level:  HF Mute:







-15 dB  
 Input

**SCRAMBLER**  
 Drive:  Blend: 



Ultra Hi  
 Ultra Lo

Volume: 

Bass:  Mid:  Treble:  AUX Level:  HF Mute:







-15 dB  
 Input

**SCRAMBLER**  
 Drive:  Blend: 



Ultra Hi  
 Ultra Lo

Volume: 

Bass:  Mid:  Treble:  AUX Level:  HF Mute:







-15 dB  
 Input

**SCRAMBLER**  
 Drive:  Blend: 



Ultra Hi  
 Ultra Lo

Volume: 

Bass:  Mid:  Treble:  AUX Level:  HF Mute:







-15 dB  
 Input

**SCRAMBLER**  
 Drive:  Blend: 



Ultra Hi  
 Ultra Lo

Volume: 

Bass:  Mid:  Treble:  AUX Level:  HF Mute:







-15 dB  
 Input

**SCRAMBLER**  
 Drive:  Blend: 

Ultra Hi  
 Ultra Lo

Volume: 

Bass:  Mid:  Treble:  AUX Level:  HF Mute:



### BA-108 TECHNICAL SPECIFICATIONS

Output Power Rating	15 watts @ 4 ohms, 10% THD+N
Signal to Noise Ratio	77 dB (20 Hz–20 kHz, unweighted)
Maximum Gain @ 1 kHz	Input: 53 dB Aux input: 44 dB
Tone Controls	Bass: +18/–20 dB @ 40 Hz Mid: +14/–15 dB @ 500 Hz Treble: +14/–15 dB @ 4 kHz
Speaker Specs	1 x 8" speaker: 4 ohms
Maximum Operating Range	40 °C ambient temperature, 93% relative humidity, up to 2000 m altitude
Power Requirements	100 VAC~ 50/60 Hz, 25W 120 VAC~ 60 Hz, 25W 220 VAC~ 50/60 Hz, 25W 240 VAC~ 50/60 Hz, 25W
Size (H x W x D)	16.8 in x 15.0 in x 12.0 in 427 mm x 381 mm x 305 mm
Weight	28 lb / 12.7 kg (approximately)

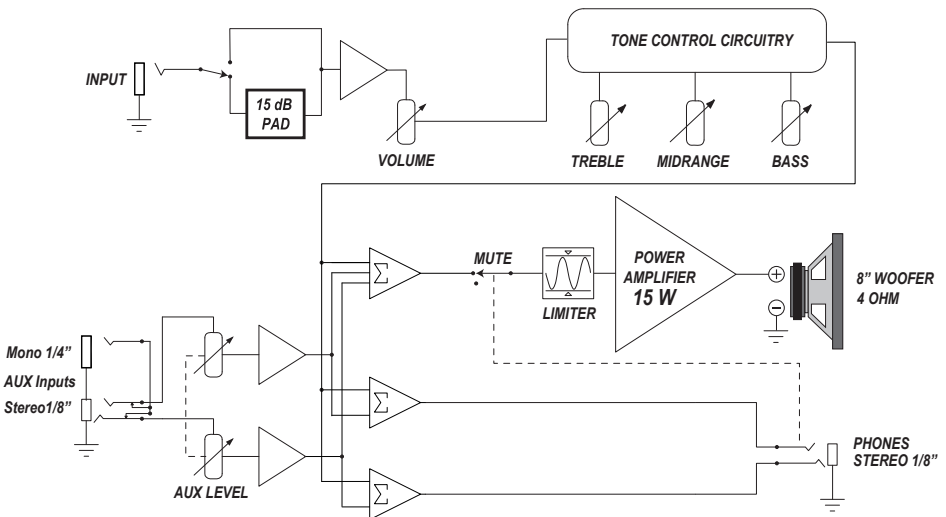



### BA-110 TECHNICAL SPECIFICATIONS

Output Power Rating	30 watts @ 4 ohms, 10% THD+N
Signal to Noise Ratio	76 dB (20 Hz–20 kHz, unweighted)
Maximum Gain @ 1 kHz	Input: 54 dB
Tone Controls	Bass: +18/–20 dB @ 40 Hz Mid: +14/–15 dB @ 500 Hz Treble: +15/–15 dB @ 4 kHz
Speaker Specs	1 x 10" speaker: 4 ohms
Maximum Operating Range	40 °C ambient temperature, 93% relative humidity, up to 2000 m altitude
Power Requirements	100 VAC~ 50/60 Hz, 35W 120 VAC~ 60 Hz, 35W 220 VAC~ 50/60 Hz, 35W 240 VAC~ 50/60 Hz, 35W
Size (H x W x D)	18.8 in x 16.0 in x 13.0 in 478 mm x 406 mm x 330 mm
Weight	33 lb / 15.0 kg (approximately)

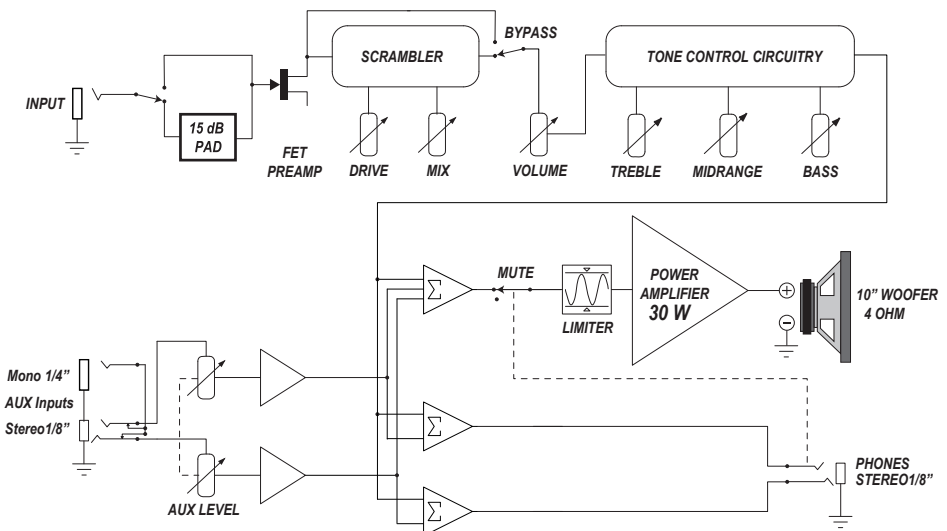



### BA-112 TECHNICAL SPECIFICATIONS

Output Power Rating	75 watts @ 4 ohms, 10% THD+N
Signal to Noise Ratio	80 dB (20 Hz–20 kHz, unweighted)
Maximum Gain @ 1 kHz	Input: 54 dB Aux input: 33 dB
Tone Controls	Bass: +14/–14 dB @ 40 Hz Mid: +5/–11 dB @ 500 Hz Treble: +15/–15 dB @ 4 kHz
Speaker Specs	1 x 12" speaker: 4 ohms
Maximum Operating Range	40 °C ambient temperature, 93% relative humidity, up to 2000 m altitude
Power Requirements	100 VAC~ 50/60 Hz, 70W 120 VAC~ 60 Hz, 70W 220 VAC~ 50/60 Hz, 70W 240 VAC~ 50/60 Hz, 70W
Size (H x W x D)	20.8 in x 18.0 in x 14.0 in 528 mm x 457 mm x 356 mm
Weight	42 lb / 19.1 kg (approximately)

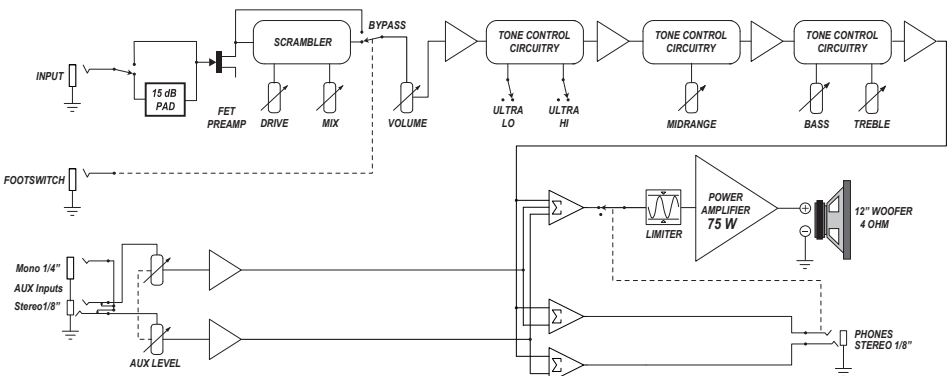



### BA-115 TECHNICAL SPECIFICATIONS

Output Power Rating	150 watts @ 8 ohms, 10% THD+N
Signal to Noise Ratio	90 dB (20 Hz–20 kHz, unweighted)
Maximum Gain @ 1 kHz	Input: 60 dB Aux input: 39 dB Effects Return: 33 dB
Tone Controls	Bass: +14/–14 dB @ 40 Hz Mid: +5/–11 dB @ 500 Hz Treble: +16/–15 dB @ 4 kHz
Speaker Specs	1 x 15" speaker: 8 ohms 1 x Piezo HF driver
Maximum Operating Range	40 °C ambient temperature, 93% relative humidity, up to 2000 m altitude
Power Requirements	100–120 VAC~ 50/60 Hz, 50W 220–240 VAC~ 50/60 Hz, 50W
Size (H x W x D)	24.8 in x 20.0 in x 15.0 in 630 mm x 508 mm x 381 mm
Weight	45 lb / 20.4 kg (approximately)

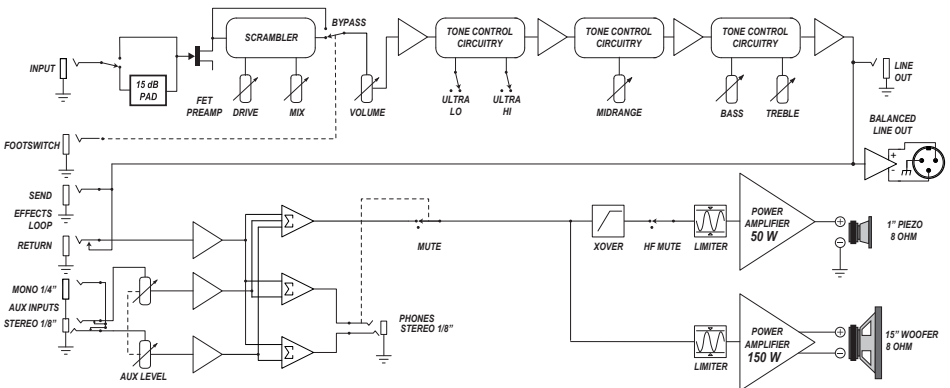



### BA-210 TECHNICAL SPECIFICATIONS

Output Power Rating	450 watts @ 4 ohms, 3% THD+N 283 watts @ 8 ohms, 10% THD+N
Signal to Noise Ratio	91 dB (20 Hz–20 kHz, unweighted)
Maximum Gain @ 1 kHz	Input: 73 dB Aux input: 52 dB Effects Return: 46 dB
Tone Controls	Bass: +14/–14 dB @ 40 Hz Mid: +5/–11 dB @ 500 Hz Treble: +16/–15 dB @ 4 kHz
Speaker Specs	2x10" speakers: 16 ohms each (8 ohms in parallel) 1 x Piezo HF driver
Maximum Operating Range	40 °C ambient temperature, 93% relative humidity, up to 2000 m altitude
Power Requirements	100–120 VAC~ 50/60 Hz, 100W 220–240 VAC~ 50/60 Hz, 100W
Size (H x W x D)	24.8 in x 20.0 in x 15.0 in 630 mm x 508 mm x 381 mm
Weight	48 lb / 21.8 kg (approximately)

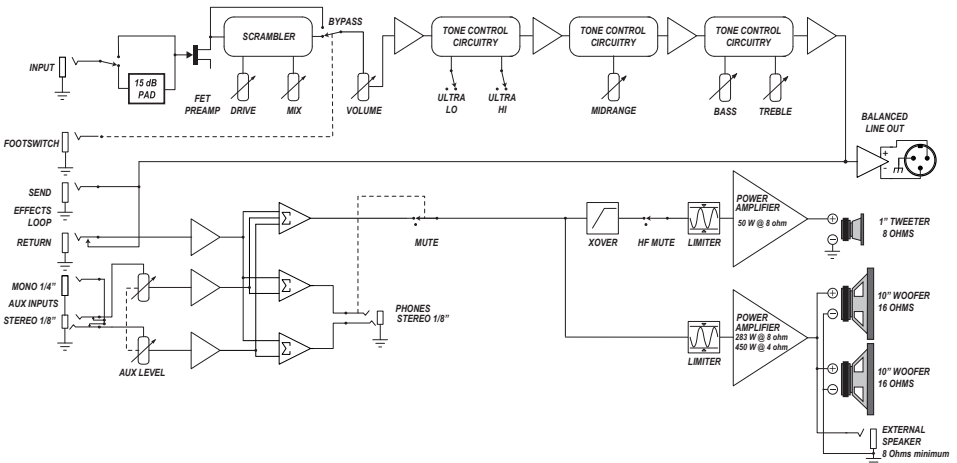



### Service Information

If you are having a problem with your BA-series combo, you can go to our website ([www.ameg.com](http://www.ameg.com)) and click on Support for service information, or call Technical Support at 1-800-898-3211 Monday-Friday during normal business hours, Pacific Time, to receive assistance. If you are outside of the U.S., contact your local distributor for technical support and service.

**BA-series combos are covered with a durable fabric-backed vinyl material, so be sure to clean it with a dry lint-free cloth. Never spray cleaning agents on the BA-series combo. Avoid abrasive cleansers which would damage the finish.**

*Ampeg continually develops new products and improves upon existing ones. For this reason, the specifications and information in this manual are subject to change without notice.*

*"Ampeg" is a registered trademark of LOUD Technologies Inc. All other brand names mentioned are trademarks or registered trademarks of their respective holders and are hereby acknowledged.*

[www.ameg.com](http://www.ameg.com)

©2014 LOUD Technologies Inc.

16220 Wood-Red Road NE • Woodinville, WA 98072

Part No. SW1064 Rev. A 03/14

# *Ampeg*

**BA-108, BA-110, BA-115, BA-112 and BA-210**

**Base Guitar Combo Amplifiers**



**Owner's Manual**